

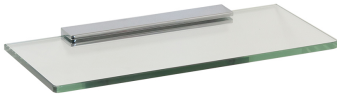

Mondrian Neu 300 Glass Shelf

Product Image



Product Details

Code:	AR93693
Brand:	Argent
Range:	Mondrian Neu
Warranty:	5 Years*

Additional Features

Technical Specification

Required Product

Recommended Products

Additional Notes

- 7.4mm Tempered Glass
- Dual Fixing

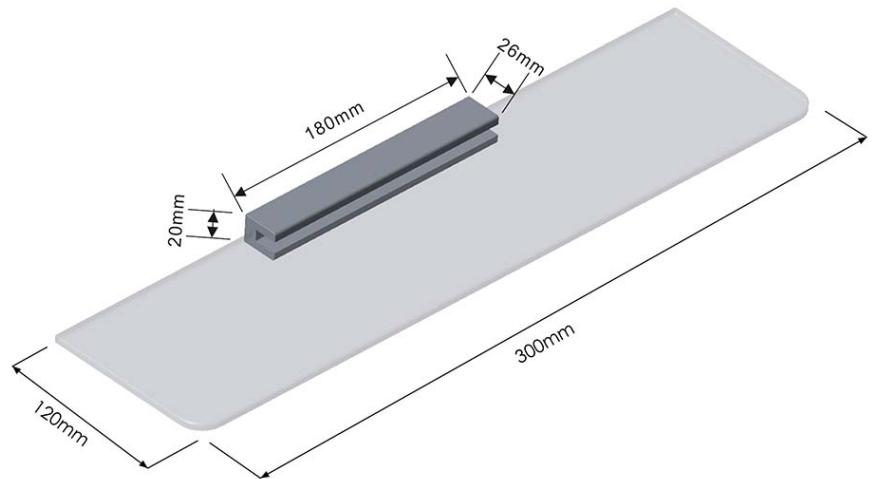

*Please visit argentaust.com.au/warranty to view the full warranty

Note: All dimensions are in millimetres and are subject to normal manufacturing variations. Always use the physical product measurements for cut-outs and rough-ins as the technical details shown may differ from the actual product. Use acetic cured silicone sealant. Do not use epoxy type adhesives. Clean with damp cloth. Do not use abrasive cleaners, liquids or pastes.

