

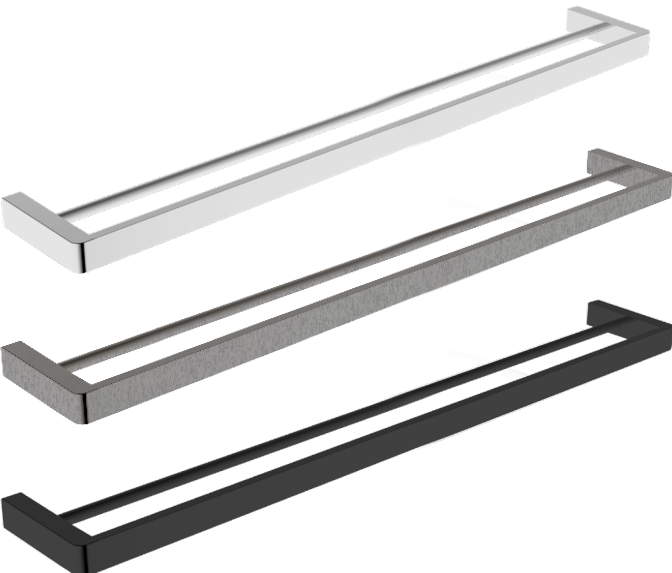
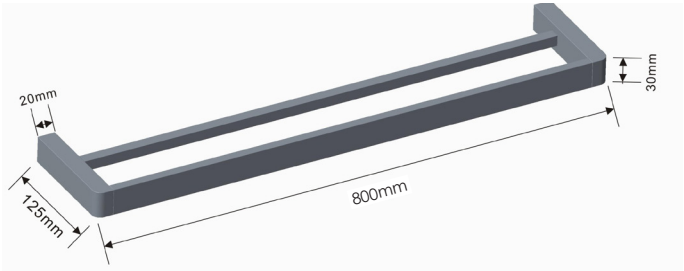

MONDRIAN NEU 800 DOUBLE TOWEL RAIL

Product Image	Technical Specification
	

Description
<p>Mondrian Neu 800 Double Towel Rail</p> <p>AR93632D Chrome AR93632DMB Matte Black AR93632DBN Brushed Nickel</p>

Additional Information
<ul style="list-style-type: none"> • 5 year warranty • Dual Fixing

