

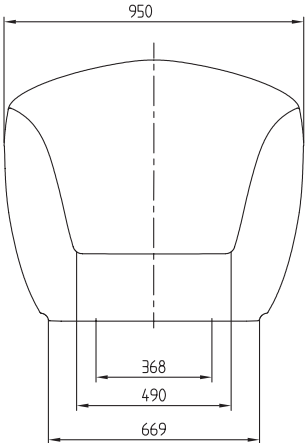
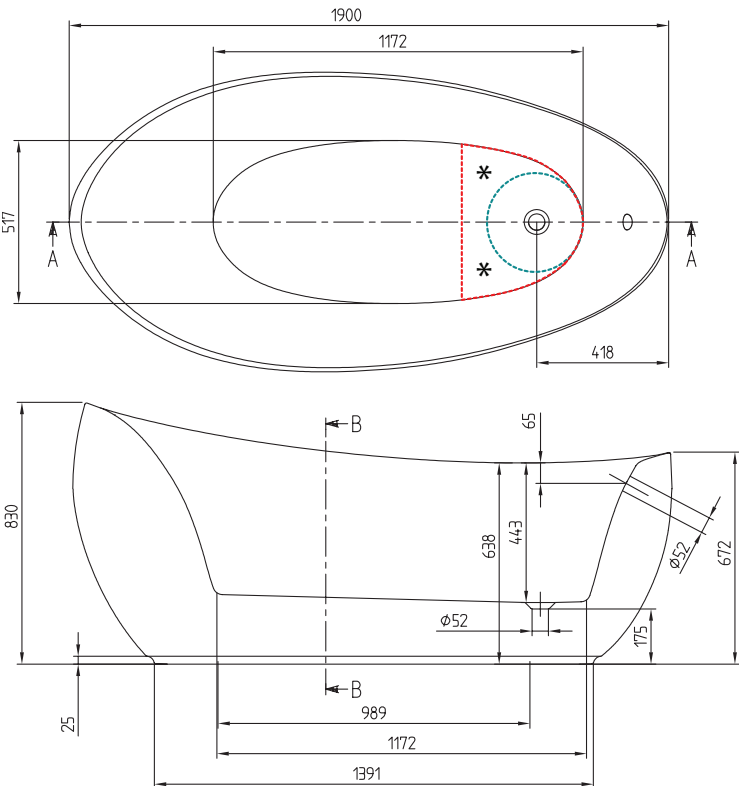

AVEO FREESTANDING BATH

Product Image	Technical Specification
 <div data-bbox="103 958 225 1077"> <p>Quaryl® Villeroy & Boch</p> </div> <div data-bbox="103 1108 336 1310"> <p>Installation Notes:</p> <ul style="list-style-type: none"> Rough-in waste position must be on 300mm radius line. Block-out/recess floor for waste within bath footprint. Recommended water supply rough-in options for Bath Filler </div>  <p style="text-align: center;">B-B</p>	 <p style="text-align: center;">A-A</p>

Description	
Aveo Freestanding Bath	
UBQ194AVE9WOB	Chrome Overflow Waste
UBQ194AVE9TWFB	Chrome Overflow Waste Bath Filler
UBQ194AVE9WWOB	White Overflow Waste
UBQ194AVE9TWWFB	White Overflow Waste Bath Filler
OPTIONAL:	
U906100PA	Multi-Function Bath Cushion, Anthracite

Additional Information
<ul style="list-style-type: none"> • Includes Waste / Overflow Combination (Overflow pre-drilled & factory integrated) • Available with optional Bath Filler (factory integrated) • For Bath Filler option, a mixed water supply rough-in point needs to be located as marked on technical drawing above • Optional Multi-Function Bath Cushion available • Made from Quaryl® • 10 Year Warranty *Conditions Apply • Weight: 109kg • Size in Litres: 245L

